

FAS3

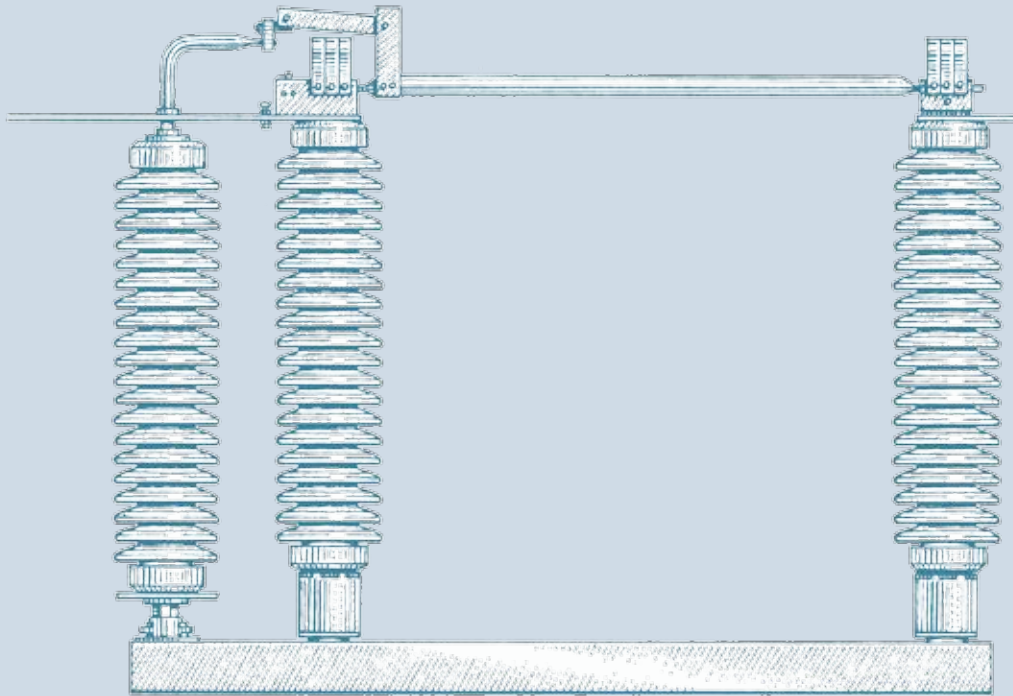

INTRODUCTION & TYPE TEST DATE : 2013		ANNUAL UNITS PRODUCED : 300	
VOLTAGE : 8.3-123 kV	BIL : 95-550 kV	CONTINUOUS CURRENT : 1200 AMPS	
SHORT CIRCUIT : 99 kA PEAK (38 kA 3 SECOND)		INSULATOR : LAPP	

The FAS3 switch is an economical three insulator vertical break design. Fabricated aluminum components are utilized throughout the design with copper plated components used in critical current transfer areas. The simplistic hinge and jaw design uses the same replaceable contacts. Switch bases are constructed of structural aluminum channel to provide minimal weight and optimal strength. The FAS3 vertical break switch design allows for mounting at minimum recommended phase spacing. Additional clearance is required for the open blade position.

Pascor Atlantic Advantages



Applications

- 105 years of continuous service to electrical industry
- IEEE & NEMA standards met
- Shortest lead time in the market
- Quality products and processes
- Enhanced factory capabilities
- Dedicated workforce
- High precision machinery
- Maintenance free bearings
- On time delivery
- Extensive technical and field service support

FAS 3

- Mounting: vertical, horizontal or inverted
- 7.5-230 kV
- 1200-2000 AMPS
- Line disconnecting, circuit breaker by pass and isolation and transformer isolation
- VEE configuration available

Standard Accessories

- Arcing horns
- Tin plated copper components used in critical current transfer areas
- Leveling screws
- Silver to Silver contacts upon request
- Sliding link interphase rods

Performance Features

- Self-cleaning/wiping jaws
- Easily field replaceable contacts
- Low maintenance
- Can be used with: Swing handle, worm gear or a motor operator
- Reverse loop contact configuration
- Hard-drawn extruded aluminum materials
- 3/4" Ice breaking
- Tested to 1,500 plus open/close operations completed
- Maintenance free bearings



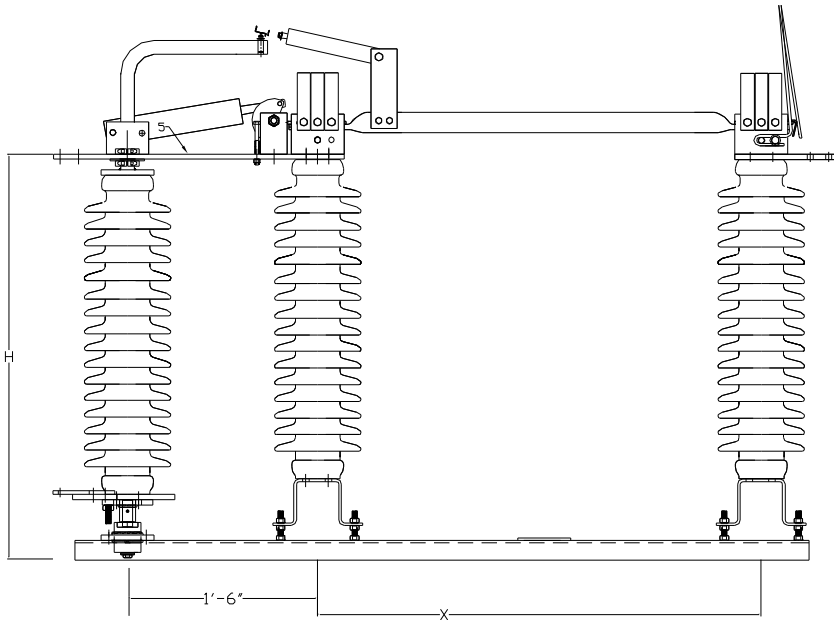

FAS3 1200A			
kV	X	H	FIG
7.5	1'-6"	1'-3 5/8"	1
15	1'-6"	1'-6 1/8"	1
23	1'-6"	1'-10 1/8"	1
34.5	2'-0"	2'-2 1/8"	1
46	2'-6"	2'-6 1/8"	1
69	3'-6"	3'-2 1/8"	1
115	5'-0"	4'-8 3/4"	2
138	6'-0"	5'-5 3/4"	2

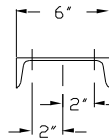

Figure 1

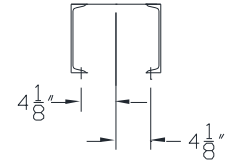
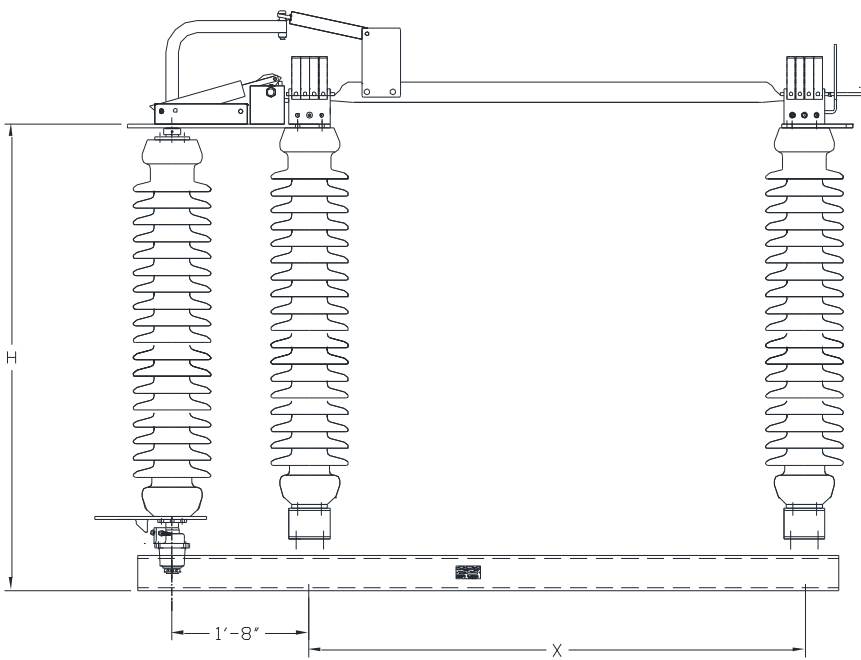

Figure 2



FAS3 2000A			
kV	X	H	FIG
7.5	3'-9"	1'-4 3/8"	1
15	2'-9"	1'-6 7/8"	1
23	2'-9"	1'-10 7/8"	1
34.5	2'-9"	2'-2 7/8"	1
46	2'-9"	2'-6 7/8"	1
69	3'-9"	3'-2 7/8"	1
115	5'-0"	4'-9 7/8"	2
138	6'-0"	5'-6 7/8"	2
161	7'-0"	6'-5 3/4"	2
230	8'-0"	7'-11 3/4"	2

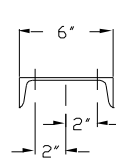

Figure 1

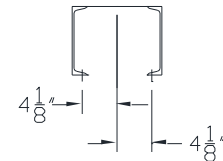

Figure 2

Pascor Atlantic
 (276) 688-3328
 254 Industry Drive
 Bland, Virginia 24315
www.pascoratlantic.com